



designwerk

OPERATING INSTRUCTIONS

Mobile DC Fast Charger MDC88-20-1.0



Original operating instructions in German

CAUTION	
	<p>Read and keep the operating instructions!</p> <p>It is imperative to read these operating instructions before putting the device into service!</p> <p>Failure to observe these instructions can result in injury, death, damage to the device and the environment.</p>

Legal Notice

Publisher	Designwerk Products AG, Wülfliingerstrasse 147, CH-8408 Winterthur P +41 44 515 48 58 info@design-werk.ch
Date of first issue	11.09.2017
Copyright	© 2017-2020 The contents of this document may not be disclosed to third parties in whole or in parts without the written approval of Designwerk Products AG. All technical specifications, drawings and pictures used are copyright protected and any infringement is punishable by law
Updates	Due to technical improvements to our products we reserve the right to make design changes. Any changes will be indicated in the individual manuals by replacing the respective pages or revision of the electronic data medium.
Creator/Author	V. O. Dettwiler

Document revision history

Version	Date	Author	Reason for change / comment
0.5	11.09.17	VDR	Document created
1.0	14.09.17	VDR	Supplements HMI and touch current notice
1.1	22.07.19	RSR	Amendments: Company name, address and notice on proper disposal
1.2	18.12.2019	VDR	Notice on proper disposal, generator operation and emergency stop added

Validity

This manual only applies to the devices listed in the following table:

Model	Code 1	Code 2
MDC88	17	1.0
MDC88	18	1.0
MDC88	19	1.0
MDC88	20	1.0

Document name		 designwerk	
Technical documentation, use and operation Mobile DC fast charger			
Author	Revision	Date	Page
V. Dettwiler, Designwerk Products AG	1.2	18th December 2019	2 / 32

Table of Contents

1	Foreword.....	4
2	Safety notice and warnings.....	4
2.1	Symbols and their meanings.....	4
2.2	Safety notices and risk levels.....	5
2.3	General safety notices.....	7
2.4	Safety devices / power limitations.....	9
2.5	User requirements.....	10
2.6	Disposal.....	11
3	General.....	12
3.1	Contents and scope of this manual.....	12
3.2	Scope complete documentation.....	12
3.3	Scope of delivery.....	13
3.4	Optional items.....	14
3.5	Manufacturer contact information.....	15
3.6	Applied standards.....	15
3.7	EG-Konformitätserklärung.....	16
4	Product use and limits.....	17
4.1	Intended use.....	17
4.2	Improper use / product limits.....	17
5	about this device.....	18
5.1	Technical data.....	18
5.2	Warnings on the device.....	19
5.3	Technical properties.....	20
5.4	Basic functions.....	20
5.5	Transport and storage information.....	20
5.6	Operating position.....	20
5.7	Product description.....	21
5.8	Nameplate.....	22
6	Use and operation.....	23
6.1	Initial state.....	23
6.2	Preparing the charger.....	23
6.3	Charging the vehicle.....	24
6.4	Generator mode.....	25
6.5	Menu structure.....	26
6.6	Stopping charging.....	29
6.7	Storing the charger after use.....	29
7	Warranty.....	30
7.1	Warranty claims.....	30
7.2	Exclusion of warranty.....	30
8	Notes.....	30
9	Appendix.....	31
9.1	Errors and warnings.....	31

Document name			
Technical documentation, use and operation Mobile DC fast charger			
Author	Revision	Date	Page
V. Dettwiler, Designwerk Products AG	1.2	18th December 2019	3 / 32

1 Foreword

Dear Customer,

Thank you for purchasing the MDC88 mobile DC fast charger, a very powerful and versatile product. Since it is a power electronics product with dangerous voltages and currents, we require specific technical skills for use and handling.



Please carefully read this manual – particularly chapter *Safety notice and warnings* – before using or working on the charger.

2 Safety notice and warnings









This chapter contains safety notices for this device. These pertain to initial use and ongoing use in the vehicle. Please read and always observe these notices for safety reasons and to prevent loss of life or damage to the device.



2.1 Symbols and their meanings



This manual uses various symbols. The following chart contains a list and what they mean:

Symbol	Designation	Symbol	Designation
	General prohibition		Caution - High voltage Do not touch
	Do not activate		

Document name			
Technical documentation, use and operation Mobile DC fast charger			
Author	Revision	Date	Page
V. Dettwiler, Designwerk Products AG	1.2	18th December 2019	4 / 32

Symbol	Designation	Symbol	Designation
	General warning of a danger zone		Warns of electric shock
	Warns of explosive environments		Warns of hazards related to batteries
	Warns of hot surface		Warns of high voltage
	Warns of high pressure / splashing liquids		Warns of fire hazards

Symbol	Designation	Symbol	Designation
	Switch off device		Disconnect device from mains

Symbol	Designation	Symbol	Designation
	Important information to avoid potential property damage		Important information

2.2 Safety notices and risk levels

Document name Technical documentation, use and operation Mobile DC fast charger			
Author V. Dettwiler, Designwerk Products AG	Revision 1.2	Date 18th December 2019	Page 5 / 32

DANGER

This notice warns of serious, irreversible injury potentially resulting in death!
Avoid this hazard by observing this notice!

WARNING

This notice warns of serious, but reversible injury!
Avoid this hazard by observing this notice!

CAUTION

This notice warns of a minor risk of injury!
Avoid this hazard by observing this notice!

NOTE

This notice warns of possible property damage if the following instructions and steps are not observed.

INFORMATION

This type of notice contains important information for the reader

Document name

Technical documentation, use and operation
Mobile DC fast charger



Author

V. Dettwiler, Designwerk Products AG

Revision

1.2

Date

18th December
2019

Page

6 / 32

2.3 General safety notices

2.3.1 Coolant system safety notices

CAUTION	
	<p>Coolant leak</p> <p>Verify the coolant system is right before putting the device into service. Discontinue use of the device if coolant leaks before or during operation.</p>

2.3.2 Mechanical system safety notices

DANGER	
	<p>Explosive environment! Danger to life!</p> <p>Do not store highly flammable substances or flammable liquids in the direct vicinity of the device! Sparks at the device connections may ignite these and result in explosions.</p>

CAUTION	
	<p>Hot surfaces and hot exhaust air. Danger of burns!</p> <p>The device produces high temperatures during operation! High temperatures particularly arise at the side covers and at the radiator grille. Therefore always use care and caution when touching these areas of the device!</p>

2.3.3 Electrical system safety notices

CAUTION	
	<p>Touch currents > 3.5 mA</p> <p>This device may produce touch currents greater than 3.5mA under certain fault conditions.</p> <p>The industrial socket must be properly earthed to ensure safe equipment operation.</p>

Document name		 designwerk	
Technical documentation, use and operation Mobile DC fast charger		Date	Page
Author	Revision	18th December 2019	7 / 32
V. Dettwiler, Designwerk Products AG	1.2		

2.3.4 Safety notices for handling and operation

NOTE

**HV battery damage**

Only use the charger on electric vehicles in good technical conditions.
Do not use the device, if the vehicle reports errors before connecting it to the charger

NOTE

**Damage to cable connections**

Check the AC and DC cable for defects before every use. Verify the cables are properly plugged in and locked.
When using AC or DC cables not included with the device, check the quality of the cables. Do not use inferior cables or cables not manufactured to standards.

2.3.5 Safety notices for electrical systems

DANGER

**High voltage!
Danger to life!**

If you are not familiar with electrical wiring, only use mode 3 connections (type 2 socket) or a In Cable Control Box designed for this purpose.

When using a Mode 1 connection, never connect the device to a socket without earth conductor! The supply line must be equipped with earth leakage circuit breaker (ELCB)!

CAUTION

**Cables overheating!
Fire hazard!**

When using a cable reel as an extension to the mains, it may ignite due to heat build-up!
Therefore always completely unwind the cable reels!

NOTE



Never open the device unauthorised! Opening the device (sealed housing) will immediately void any warranty and guarantee claims against Designwerk Products AG!

Document name

Technical documentation, use and operation
Mobile DC fast charger



Author
V. Dettwiler, Designwerk Products AG

Revision
1.2

Date
18th December
2019

Page
8 / 32

2.4 Safety devices / power limitations

2.4.1 Coded CEE cables

When using the power cables sold separately, the device will automatically detect the cable and limit the current to the maximum permissible current. When using any other cable, the device will enter safety mode and only draws a very limited amount of current. This setting can be manually adjusted up or down in the menu.

NOTE



Only use the included AC cables. When using a standard AC cable on a mains socket with electric lock may result in malfunctions. Connecting standard CEE Extension cables after the included AC cables is permissible.

2.4.2 Mains overvoltage protection

The charger has a built-in overvoltage protection to continuously protect the charger from overload damage. The quick sensor system even detects minor electrical surges in the mains and immediately specifically shut down and restart the charger. High-energy surges (e.g. lightning strikes) are intercepted by protective elements. The output end also has a built-in overvoltage protector. The quick sensor system detects surges on the HV battery end (e.g. load shedding or load fluctuations) and immediately specifically shut down and restart the charger.

2.4.3 Input current main fuse

Each phase (L1, L2, L3, N) of the charger is equipped with four 40 A fuses to protect the device and the electrical installations from damage due to electrical surges. If one of these fuses is tripped, the fuses can always be reset using the flap at the back of the device. The error must first be examined in detail.

2.4.4 Overcurrent protection

The charger has a built-in overcurrent protection to continuously protect the charger from overload damage. Surges in the mains are detected by the quick sensor system and depending on the level are either reduced or result the charger being specifically shut down and restarted. The mains input on the charger is further equipped with safety devices to also immediately shut down the charger in an emergency.

2.4.5 Overload protection (derating)

This device is designed to work without reduced charging power (derating) up to an outside air temperature of +30°C. In the event of extreme continuous operation or in outside air temperatures over 30°C, the device automatically reduces the charging power to protect the charger from damage due to overheating. Power is reduced proportional to the temperature rise until the device temperature is within the target range again.

Document name Technical documentation, use and operation Mobile DC fast charger			
Author V. Dettwiler, Designwerk Products AG	Revision 1.2	Date 18th December 2019	Page 9 / 32

2.4.6 Active discharge

The device features active discharge of the circuits. As soon as the device is disconnected from the HV voltage, the internal HV circuits discharge:

2.5 User requirements

This device may only be operated using a Mode 1 connection (industrial or country-specific sockets) by a trained electrician or a person trained for this purpose.

A qualified electrician or trained person is defined as a person with

- professional training or instruction,
- knowledge and experience in electrical or electromobility,
- as well as knowledge of the relevant regulations and hazards

and able provide proof thereof. They must further be able to independently assess their assigned tasks, recognise potential hazards, and determine the necessary safety measures.

INFORMATION	
	<p>Using industrial or country-specific sockets</p> <ul style="list-style-type: none"> - Check the cables and plugs being used for damage - Check the mains installation for fuses (LS) and earth leakage detection (ELCB) - Completely unwind the connecting cables to avoid heat built-up - Insert plugs correctly and fully - Avoid connecting whilst live

INFORMATION	
	<p>Manually reducing the device current</p> <p>All included CEE cables are coded to limit the maximum current. If connections (e.g. worksite distribution boards) are unable to safely handle the rated current for any reason, the maximum current can also be manually limited in the fast charger menu.</p>

Document name Technical documentation, use and operation Mobile DC fast charger			
Author V. Dettwiler, Designwerk Products AG	Revision 1.2	Date 18th December 2019	Page 10 / 32

2.6 Disposal

This device is marked in accordance with directive 2012/19/EU on Waste Electrical and Electronic Equipment – WEEE. The directive provides the framework for the EU-wide take-back and recycling of waste equipment.

Disposing through regular household waste is not permitted. To ensure proper disposal, the device must be returned to Designwerk Products AG or an electrical retailer.

This charger is made of recyclable materials. Local regulations may require separate disposal of electrical and electronic products, including cables, plugs and accessories.

INFORMATION



Never dispose of waste devices with household waste.
To ensure proper disposal, the device must be returned to Designwerk Products AG or an electrical retailer.

Our WEEE registration no. DE 42721147

Document name

Technical documentation, use and operation
Mobile DC fast charger



Author

V. Dettwiler, Designwerk Products AG

Revision

1.2

Date

18th December
2019

Page

11 / 32

3 General

3.1 Contents and scope of this manual

This documentation provides the reader with an overview of all steps required to install and operate the charger and the necessary safety mechanisms.

It further contains technical data, application information and a basic description of the charger and its functions.

The operating information and safety notices must be followed exactly to ensure proper charger function long-term and to comply with the warranty requirements of Designwerk Products AG.

3.2 Scope complete documentation

The operating instructions contain the following documents

- Technical documentation
- EU Declaration of Conformity
- Use and operation
- Warranty terms

Document name Technical documentation, use and operation Mobile DC fast charger			
Author V. Dettwiler, Designwerk Products AG	Revision 1.2	Date 18th December 2019	Page 12 / 32

3.3 Scope of delivery

Designation		Item no.	Illustration
1	Fast charger Optional: DC cable AC cable Wheels	17.0443.000	

Document name

Technical documentation, use and operation
Mobile DC fast chargerAuthor
V. Dettwiler, Designwerk Products AGRevision
1.2Date
18th December
2019Page
13 / 32

3.4 Optional items

	Designation	Item no.	Illustration
1	DC cable CHAdeMO 200A 4m	17.0443.525	
2	DC cable CCS Type 2 200A 4m	17.0443.524	
3	DC cable CCS Type 1 200A 6m	17.0443.522	
4	DC cable GB/T 200A 4m	On request	
5	Tesla CHAdeMO adapter	15.0184.537	
6	AC cable CEE 63A 5m	17.0443.512	
7	AC cable CEE 125A 5m	17.0443.511	
8	Wheels	17.0443.380	

Document name

Technical documentation, use and operation
Mobile DC fast charger



Author
V. Dettwiler, Designwerk Products AG

Revision
1.2

Date
18th December
2019

Page
14 / 32

3.5 Manufacturer contact information

Designwerk Products AG

Wülflingerstrasse 147

CH-8408 Winterthur

Ph +41 44 515 48 58

info@design-werk.ch

3.6 Applied standards

The mains end of the device was designed according to 2006/95/EU low voltage directive and on the HV end according to IEC 62196-3 DC charging.

The device is only approved for the European region.

This manual was written applying and in compliance with the EU directives, national laws and harmonised standards (EN) applicable to the fast charger product at the time it was written.

Document name Technical documentation, use and operation Mobile DC fast charger			
Author V. Dettwiler, Designwerk Products AG	Revision 1.2	Date 18th December 2019	Page 15 / 32

3.7 EG-Konformitätserklärung

EU Declaration of conformity
CE-Déclaration de conformité
CE-Dichiarazione di conformità



Wir Designwerk Products AG
We Wülflingerstrasse 147
Nous 8408 Winterthur
Noi Schweiz
Tel: +41 44 515 48 58

erklären in alleiniger Verantwortung, dass das Produkte Mobile DC fast charger
hereby declare in our sole responsibility, that the product MDC88-17-1.0 SN20001-20010
déclarons de notre seule responsabilité, que le produit
dichiariamo di nostra sola responsabilità

auf das sich diese Erklärung bezieht, mit den folgenden Normen oder normativen Dokumenten
übereinstimmt.

which is the subject of this declaration, is in conformity with the following standards or normative documents.
Auquel cett déclaration se rapporte, est conforme aux normes ou aux documents normatifs suivants.
Al quale si fa riferimento in questa dichiarazione, é conforme alle norme o ai documenti normativi seguenti.

2006/42/EU	Maschinenrichtlinie Machinery Directive Directive Machines Direttiva Maccine	2006/95/EU	Niederspannungsrichtlinie Low Voltage Directive Directive pour basses tensions Direttiva per bassa tensione
IEC 62196-3 IEC 61851-1, -24	Gleichstromladung Direct current charge Rechargez courant continu Caricare corrente continua	EN 61000-6-2, -4	EMV Störfestigkeit, -aussendung, Grenzen EMC Immunity, emission, limits EMC Immunité, émis, limite EMC immunità, emessa, limiti

Anbringung der CE-Kennzeichnung: 2017

Placing the CE-Mark:

Application de la marque distinctive

CE:

Applicazione del marchio CE:

Bei einer nicht mit uns abgestimmten Änderung des Produktes verliert die Erklärung ihre Gültigkeit.

Any modification of this product without confirmation shall automatically annul this declaration.

Toute modification des produits sans autorisation de notre part rendra cette déclaration invalide.

In caso di modifica del prodotto non concordata con noi, la dichiarazione decade.

Place:

Date:

Frank Locker, CTO

Winterthur

14th November 2017

Document name Technical documentation, use and operation Mobile DC fast charger			
Author V. Dettwiler, Designwerk Products AG	Revision 1.2	Date 18th December 2019	Page 16 / 32

4 Product use and limits

4.1 Intended use

The DC fast charger is generally designed for charging a variety of electric and hybrid vehicles with DC fast charge connector. If you intend to use it for any other purposes, please contact Designwerk Products AG with any questions.

The user must ensure not to exceed the specific operating limits of the connected vehicle and the fast charger during all charging phases.

Only use the charger within the limits specified in the next subchapter.

4.2 Improper use / product limits

Improper means any use in conditions and under requirements which do not comply with those specified by the manufacturer in the technical documentation and data sheets.

The following limits have been defined for operating the fast charger. Operation outside these defined limits may damage the device and as a result life-threatening situations, and is therefore prohibited!

NOTE



The operating limits of the connected vehicle must also be observed.

Limit type	Value to be met	Unit
3-phase input voltage	360-440	V
3-phase input current	32-128A	A
Ambient temperature for storage	-20 to +70	°C
Ambient temperature for operation	-20 to +40	°C
Max. device operating height	3000	above sea level

Document name

Technical documentation, use and operation
Mobile DC fast charger



Author
V. Dettwiler, Designwerk Products AG

Revision
1.2

Date
18th December
2019

Page
17 / 32

5 About this device

5.1 Technical data

AC input	Value	Unit
3-phase input voltage	360-440	VAC
3-phase input current	32-128	A
Input frequency	45-65	Hz
Max. input power	88	kW
Power factor	> 0.99	-
Power Factor Correction (PFC)	Yes	-
Mains fuse all phase	2x40	A
Lightning protection overvoltage protection IEC61000-4-5	Class 2	-
X capacity	9.4	µF
Y capacity L1 ->PE	40	nF

DC output	Value	Unit
Voltage range with reduced power	280-310, 430-450	VDC
Voltage range at full power	310-430	VDC
Charging current with reduced power	80	A
Charging current at full power	240	A
Charging power with reduced power	26	kW
Charging power at full power	83	kW
Efficiency below 26kW	> 90	%
Efficiency over 26kW	> 94	%
Max. Charging current ripple at max. power	<16	Aeff
Active discharge output capacitor	Yes	-

Document name			
Technical documentation, use and operation Mobile DC fast charger			
Author	Revision	Date	Page
V. Dettwiler, Designwerk Products AG	1.2	18th December 2019	18 / 32

Thermal/cooling system	Value	Unit
Coolant volume in device	3	L
Coolant mixing ratio (glycol/water)	50 / 50 (min -20°C)	%
Ambient temperature for storage	-20 to +70	°C
Ambient temperature for operation	-20 to +40	°C
Max. device operating height	3000	above sea level
Max. airflow	1200	m ³ /h

Basic mechanical data	Value	Unit
Weight (without cables)	94	Kg
Housing material	AlMgSi1 powder-coated	-
Housing volume	252	L
IP rating	54	-
Height	770	mm
Width	600	mm
Length	600	mm

Safety and protection functions	Value	Unit
Isolation between mains input and DC output	LV123 / IEC61851	-
Mains input overvoltage protection	264	V
Open circuit protection	Yes	-
Internal overvoltage protection	Yes	-
Temperature sensor	various	-
Charging cable plug lock	Yes	-
Isolation resistance (initial) min.	>5	MΩ

5.2 Warnings on the device

The air outlet grille has a "Risk of burns" warning



and a "electrical high voltage" warning at the DC sockets



Document name Technical documentation, use and operation Mobile DC fast charger			
Author V. Dettwiler, Designwerk Products AG	Revision 1.2	Date 18th December 2019	Page 19 / 32

5.3 Technical properties

Despite the impressive 88kW charging power, the DC fast charger is small and light. This allows both mobile as well as stationary use of the device.

The built-in power factor correction (PFC) and the galvanic isolation between the mains and HV battery ensure the device offers both maximum power as well as maximum safety when charging electric and hybrid vehicles.

The device has a low battery current ripple for particularly battery-friendly charging, even at high charging powers.

The fast charger is particularly suitable for vehicles with no or very inefficient on-board charger.

5.4 Basic functions

The fast charger charges electric and hybrid vehicles with DC connection such as CCS Combo Type 2, Type 1 and CHAdeMO.

5.5 Transport and storage information

The charger must be transported and stored upright. Transporting the device horizontally or overhead is not advisable. Always ensure the device cannot shift during transport.

When using the wheels, the device can be transport by forklift or hand pallet truck. When using a forklift without laterally adjustable forks, be careful not to damage the wheels. In this case, picking up the load at a 45° angle is safest.

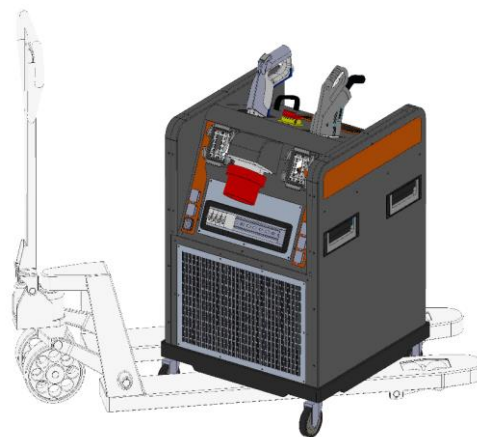

5.6 Operating position

The device should be operated upright, with the display facing up.

NOTE



It's important to keep the face sides free from objects to allow optimal circulation of the cooling air.

Document name

Technical documentation, use and operation
Mobile DC fast charger

Author
V. Dettwiler, Designwerk Products AG

Revision
1.2

Date
18th December
2019

Page
20 / 32

5.7 Product description

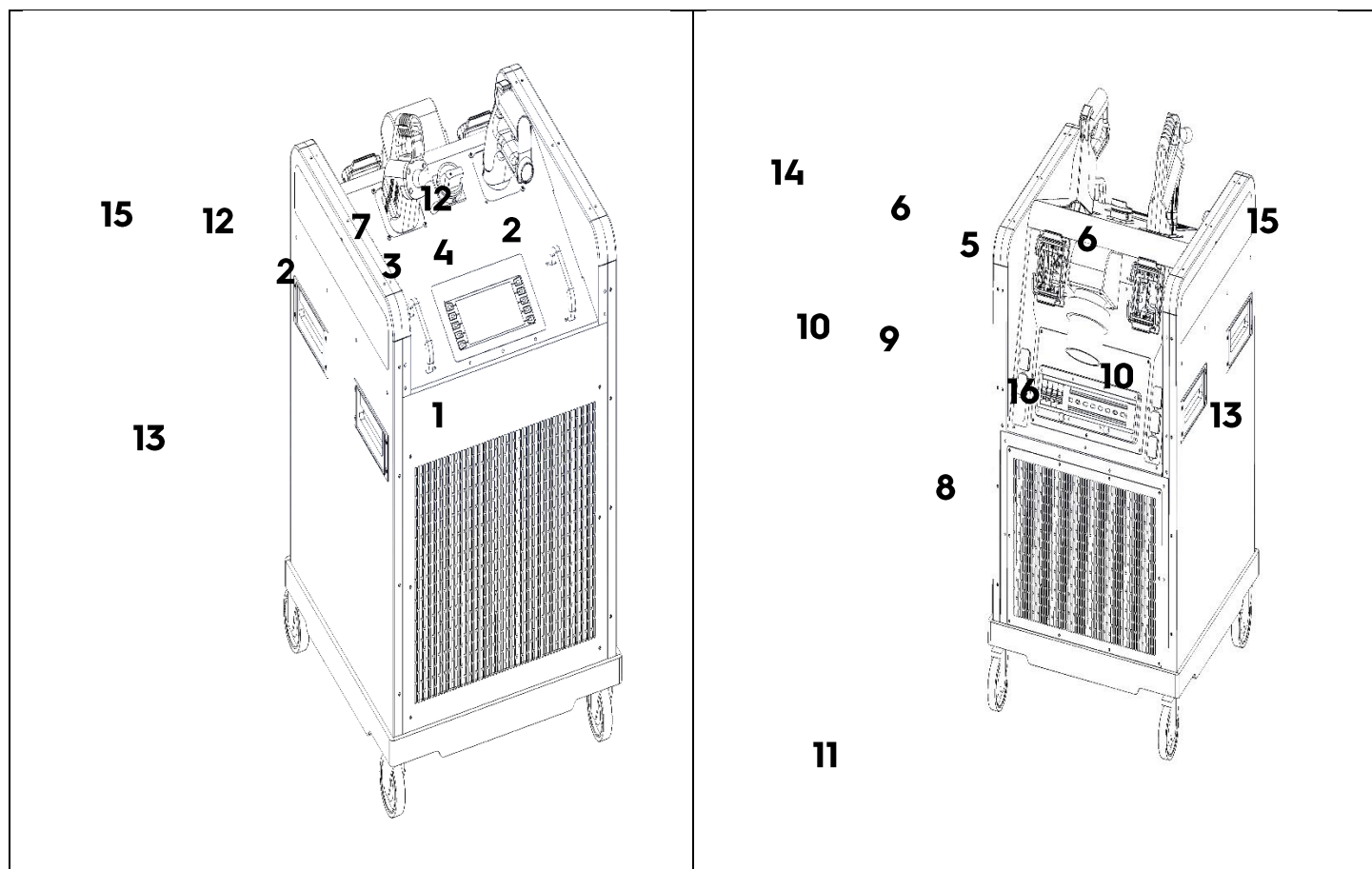

1	Air outlet	9	Nameplate
2	Manoeuvring handles	10	Diagnostic connections
3	Display	11	Wheels
4	Control buttons	12	DC vehicle plug park positions
5	AC mains connections	13	Carrying handles
6	DC cable connection port A and B	14	Cable rewind wing
7	Main switch	15	Product identification
8	Air intake	16	Circuit breaker access

Document name			
Technical documentation, use and operation Mobile DC fast charger			
Author	Revision	Date	Page
V. Dettwiler, Designwerk Products AG	1.2	18th December 2019	21 / 32

5.8 Nameplate

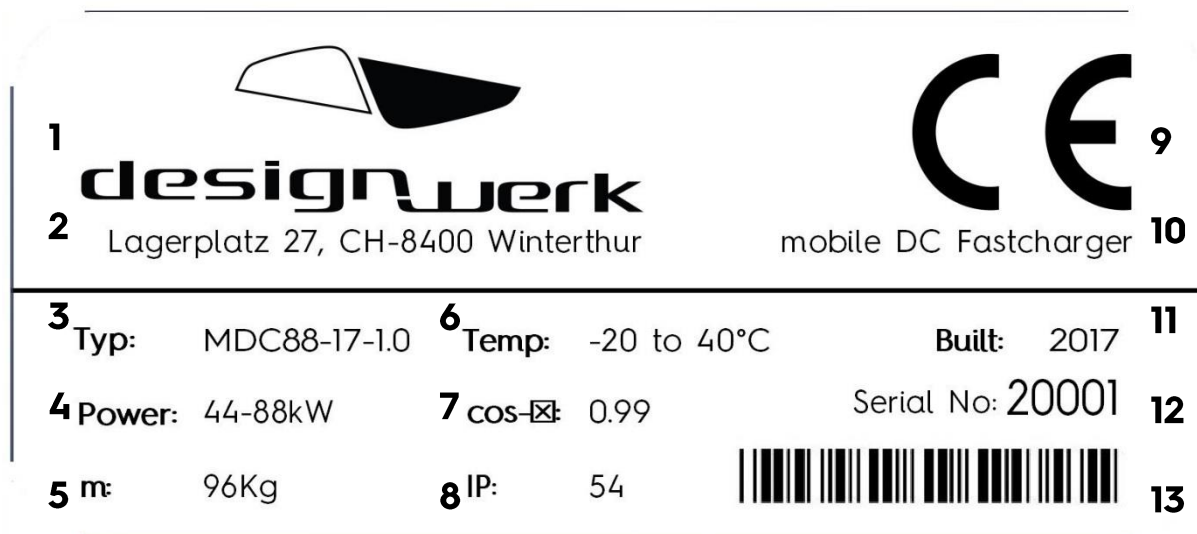

1	Company logo	8	IP rating
2	Company address	9	CE mark
3	Type designation	10	Voice device name
4	Input power range	11	Year of manufacture
5	Device weight	12	Serial number
6	Permissible temperature range during operation	13	Barcode
7	Power factor correction (PFC)		

Document name			
Technical documentation, use and operation Mobile DC fast charger			
Author	Revision	Date	Page
V. Dettwiler, Designwerk Products AG	1.2	18th December 2019	22 / 32

6 Use and operation

6.1 Initial state

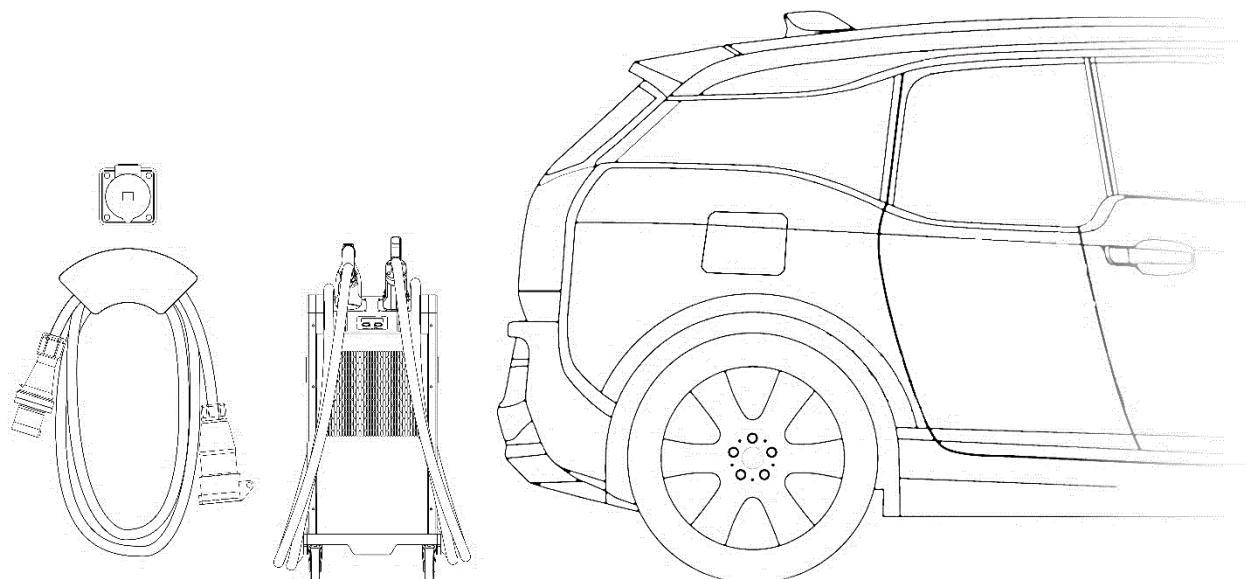

Fast charging requires a preferably powerful mains connection, optimally CEE125A/400V industrial socket. Park your vehicle so the fast charger with included cables reaches the mains connection and the cables are on the ground, not taut.

6.2 Preparing the charger

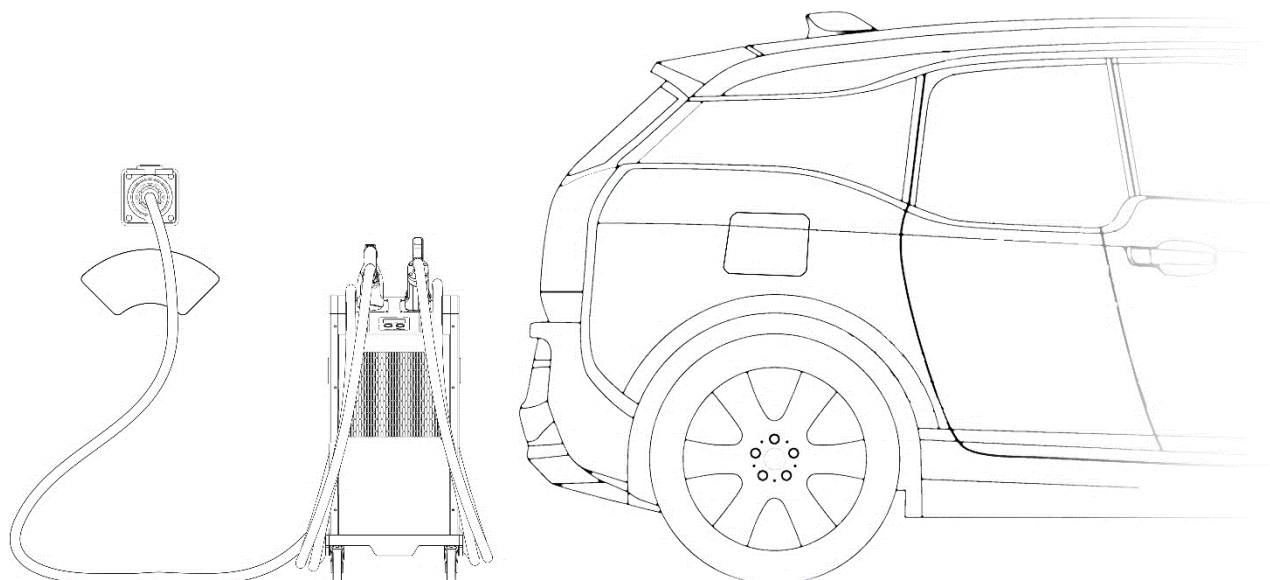

Plug the DC cable and the AC cable into the fast charger. Now connect the AC cable to the mains.

Document name		 designwerk	
Technical documentation, use and operation Mobile DC fast charger			
Author	Revision	Date	Page
V. Dettwiler, Designwerk Products AG	1.2	18th December 2019	23 / 32

6.3 Charging the vehicle

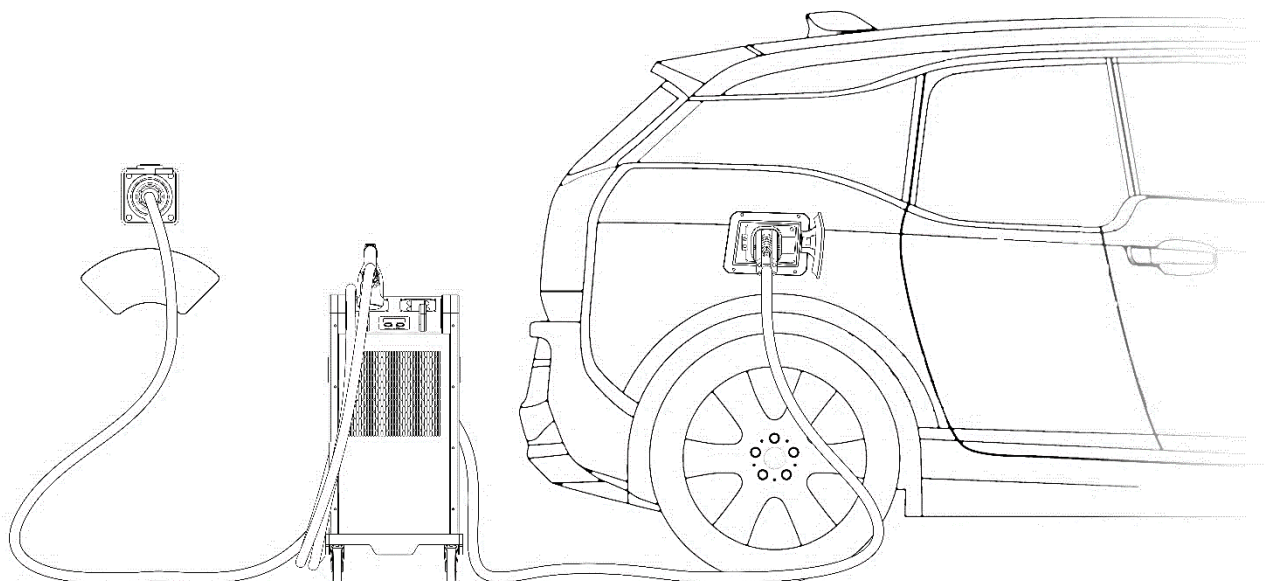

Now plug the DC plug into your vehicle. Depending on the charging protocol, fast charging will start automatically or you will need to press the START button on the fast charger. Browse the menu structure for informational data during charging.

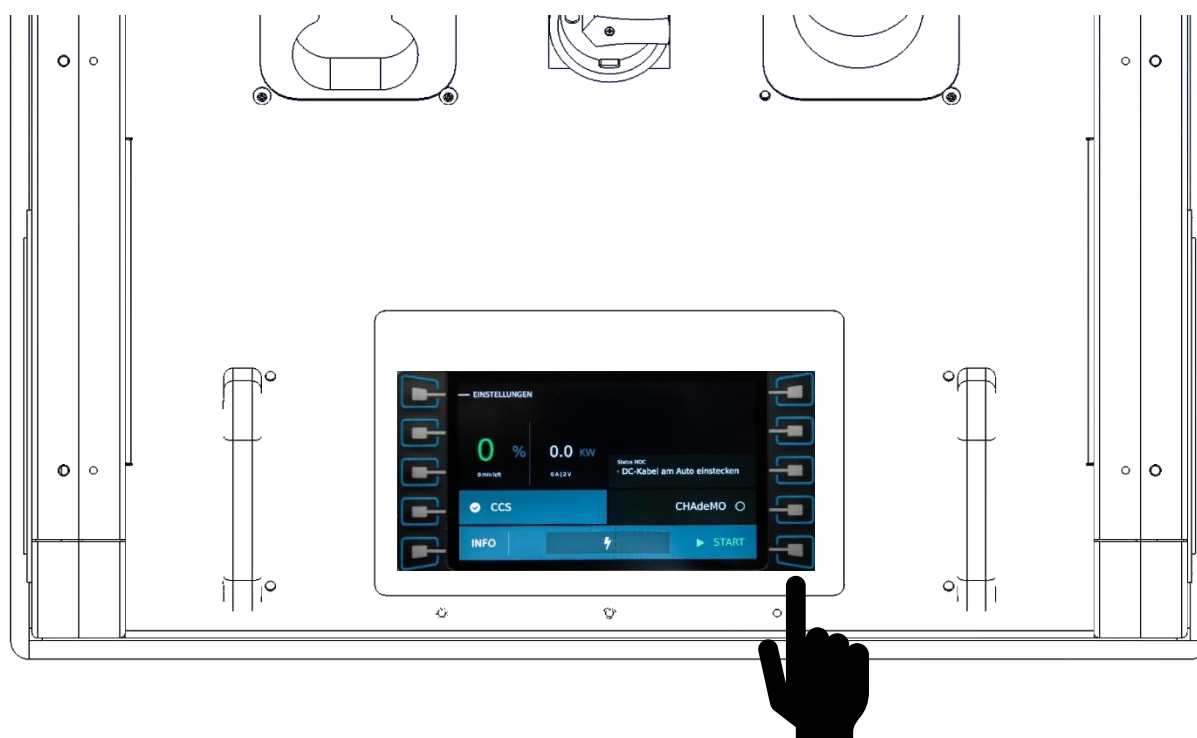

Document name Technical documentation, use and operation Mobile DC fast charger			
Author V. Dettwiler, Designwerk Products AG	Revision 1.2	Date 18th December 2019	Page 24 / 32

6.4 Generator mode

MDC products are not designed for mains operation. In this function, it responds very reactively to changes in the voltage, frequency or other parameters. If minor changes occur, charging will be interrupted or reduced. This can cause problems if the MDC is powered by a generator. Generator mode can be helpful if rapid increases or decreases are a problem.

NOTE



Generator mode must be activated if more than one MDC is connected to a generator.
Generator mode can be activated from the display. You can then select a current from 0A / s to 240A / s.

Document name

Technical documentation, use and operation
Mobile DC fast charger



Author
V. Dettwiler, Designwerk Products AG

Revision
1.2

Date
18th December
2019

Page
25 / 32



6.5 Menu structure

	<p>Home screen</p> <p>This displays all information necessary for the user for normal operation.</p> <p>You can access the following from this screen:</p> <ul style="list-style-type: none"> - Settings - Select charging port A or B - Start / Stop - Info
	<p>Info screen</p> <p>This screen provides additional information on the current charging process. At the bottom is the status bar with the Start /Stop button.</p> <p>You can access the following from this screen:</p> <ul style="list-style-type: none"> - Back to Home - Temperatures screen - AC information screen - Error message screen
	<p>Temperatures screen</p> <p>This displays the current temperatures for the respective measuring points.</p> <p>At the bottom is the status bar with the Start /Stop button.</p>

<p>Document name</p> <p>Technical documentation, use and operation Mobile DC fast charger</p>			
<p>Author</p> <p>V. Dettwiler, Designwerk Products AG</p>	<p>Revision</p> <p>1.2</p>	<p>Date</p> <p>18th December 2019</p>	<p>Page</p> <p>26 / 32</p>

	<p>AC information screen</p> <p>This screen displays information about the current status of the mains connection.</p> <p>At the bottom is the status bar with the Start /Stop button.</p>
	<p>Error message screen</p> <p>This displays any errors. Errors can be deleted at the top right.</p> <p>At the bottom is the status bar with the Start /Stop button.</p>
	<p>Settings screen</p> <p>In this screen you can change settings and parameters.</p> <p>At the bottom is the status bar with the Start /Stop button.</p> <p>You can access the following from this screen:</p> <ul style="list-style-type: none"> - Current limit - Language - Device info
	<p>Current limit screen</p> <p>Here you can set the power limits on the input and output end. The selectable limit is limited by the coded AC connecting cable connected on the mains end.</p> <p>At the bottom is the status bar with the Start /Stop button.</p>

<p>Document name</p> <p>Technical documentation, use and operation Mobile DC fast charger</p>			
<p>Author</p> <p>V. Dettwiler, Designwerk Products AG</p>	<p>Revision</p> <p>1.2</p>	<p>Date</p> <p>18th December 2019</p>	<p>Page</p> <p>27 / 32</p>

	<p>Language screen</p> <p>In this screen you can select the language.</p> <p>At the bottom is the status bar with the Start /Stop button.</p>
	<p>Device info screen</p> <p>This screen displays the software versions and the operating data since being commissioned.</p> <p>At the bottom is the status bar with the Start /Stop button.</p>

Technical changes to the menu structure reserved.

<p>Document name</p> <p>Technical documentation, use and operation Mobile DC fast charger</p>			
<p>Author</p> <p>V. Dettwiler, Designwerk Products AG</p>	<p>Revision</p> <p>1.2</p>	<p>Date</p> <p>18th December 2019</p>	<p>Page</p> <p>28 / 32</p>

6.6 Stopping charging

Charging automatically ends when the battery is full. Depending on the vehicle you will then merely need to disconnect the DC plug from the vehicle or first unlock the charging port in the vehicle or with the keyless remote.

To stop charging before the battery is fully charged, press the STOP button (shutdown). You can now charge other vehicles or store the device away.

NOTE



Holding the STOP button will result in an EMERGENCY STOP, thus immediately stopping the charging process.

6.7 Storing the charger after use

The device cooling may keep running at full power after charging stops. However, you can still unplug the device and pack it up, however please note the device may be hot.

To disconnect the device from the mains, first press the main switch. You can then unplug both ends of the AC cable. To store the device away, you will now merely need to disconnect the DC cable from the device.

When storing the device away, please note the transport and storage information in chapter 6.5.

Document name			
Technical documentation, use and operation Mobile DC fast charger			
Author	Revision	Date	Page
V. Dettwiler, Designwerk Products AG	1.2	18th December 2019	29 / 32

7 Warranty

Designwerk Products AG offers a 24-month warranty from the date of purchase for obvious defects in function, material and manufacture. The warranty is valid within the European Union and the EFTA countries and is designed as a bring-in warranty.

7.1 Warranty claims

- Please always contact us before sending in the product. We will then discuss further proceedings with you.
- If the defect is covered by our warranty, you will receive a repaired or new device.

7.2 Exclusion of warranty

The warranty is immediately void if the seal on the housing is damaged due to unauthorised opening or missing entirely. Designwerk Products AG further assumes no liability for damages due to handling or using the device improperly or incorrectly.

Designwerk Products AG assumes no liability for personal injury due to failure to observe the general and/or product-specific safety notices.

Designwerk Products AG assumes no liability for damage to peripherals associated with this device. If you are unsure about using this product, please contact our support team PRIOR to use.

8 Notes

We reserve the right to make changes in the interest of technical advancements. Designwerk Products AG cannot guarantee that all requirements, regulations and standards are free of third-party industrial property rights.

Document name			
Technical documentation, use and operation Mobile DC fast charger			
Author	Revision	Date	Page
V. Dettwiler, Designwerk Products AG	1.2	18th December 2019	30 / 32

9 Appendix

9.1 Errors and warnings

No.	Group	Category	Text	Action	Permitted number
1	0	General	Charger error	Switch off device (disconnect all cables) and restart the charging process	1x
2	0	General	Error communicating with charger	Switch off device (disconnect all cables) and restart the charging process	1x
3	0	General	Mains voltage lost	Check the input end for mains voltage (fuses)	3x
4	0	General	Interlock error	Verify the cable on the vehicle is correctly connected to the fast charger and the lock is closed	1x
5	0	General	Insufficient cooling capacity warning	Verify the air intake and air outlet are clear and air can circulate	-
17	0	CHAdEMO	Battery overvoltage	Vehicle error Shut off and restart vehicle	1x
18	0	CHAdEMO	Low battery voltage	Vehicle error Shut off and restart vehicle	1x
19	0	CHAdEMO	Current difference	Vehicle error Shut off and restart vehicle	1x
20	0	CHAdEMO	Battery temperature high	Wait, then restart charging	
21	0	CHAdEMO	Voltage difference	Vehicle error Shut off and restart vehicle	1x
22	0	CHAdEMO	Gear lever position	Put vehicle in 'P'	-
23	0	CHAdEMO	Other vehicle error	Vehicle error Shut off and restart vehicle	1x
24	0	CHAdEMO	Battery compatibility	Charger incompatible with vehicle	1x
25	1	CHAdEMO	Battery error whilst connecting	Vehicle error Shut off and restart vehicle	1x
26	1	CHAdEMO	Communication error whilst connecting	Vehicle error Shut off and restart vehicle	1x
27	1	CHAdEMO	Initiate charging error	Vehicle error Shut off and restart vehicle	1x
28	1	CHAdEMO	Voltage during isolation test	Vehicle error Shut off and restart vehicle	1x
29	1	CHAdEMO	Plug not locked	Vehicle error Shut off and restart vehicle	1x
30	1	CHAdEMO	Current requirement too high	Vehicle error Shut off and restart vehicle	1x
31	1	CHAdEMO	No current requirement	Vehicle error Shut off and restart vehicle	1x
32	1	CHAdEMO	Communication error whilst charging	Vehicle error Shut off and restart vehicle	1x
33	2	CHAdEMO	Unable to reduce voltage	End of charge error Please contact the manufacturer if this error persists.	-
34	2	CHAdEMO	Isolation test error	Check vehicle charging cable for damage	1x
35	2	CHAdEMO	Isolation test warning	Check vehicle charging cable for damage	-
41	0	CCS	Internal communication error	Switch off device (disconnect all cables) and restart the charging process	1x
42	0	CCS	Charging plug temperature	Check charging plug for damage. Be sure to insert the plug	1x

Document name

Technical documentation, use and operation
Mobile DC fast charger



Author
V. Dettwiler, Designwerk Products AG

Revision
1.2

Date
18th December
2019

Page
31 / 32

			high	correctly	
43	0	CCS	Isolation test error	Check vehicle charging cable for damage	1x
44	0	CCS	Maximum precharge time exceeded	May occur if the charger was exposed to very low temperatures.	3x
49	1	CCS	Charging plug temperature high	Check charging plug for damage. Be sure to insert the plug correctly	-
50	1	CCS	Isolation test warning	Check vehicle charging cable for damage	-
57	2	CCS	Vehicle temperature limit	If this error persists, continue charging later.	1x
58	2	CCS	Vehicle gear position	Put vehicle in "P"	1x
59	2	CCS	Plug lock vehicle error	Verify the plug is inserted correctly	1x
60	2	CCS	Vehicle battery fault		1x
61	2	CCS	Vehicle current deviation		1x
62	2	CCS	Vehicle voltage outside range		1x
63	2	CCS	Vehicle charging system incompatible		1x
78	1	Charger	Excess internal temperature		
81	2	Charger	Communication error		
82	2	Charger	Communication error		
83	2	Charger	Voltage interruption on mains side		
84	2	Charger	DC voltage outside permissible range		
85	2	Charger	Excess input connector temperature		
105	5	Charger	Power reduction		
106	5	Charger	High internal temperature warning		
113	6	Charger	Communication error		
114	6	Charger	Communication error		
115	6	Charger	Communication error		
116	6	Charger	Communication error		
120	6	Charger	Input connector lock warning		
122	7	Charger	Mains voltage impermissible		
123	7	Charger	Mains frequency impermissible		

Document name

Technical documentation, use and operation
Mobile DC fast charger



Author
V. Dettwiler, Designwerk Products AG

Revision
1.2

Date
18th December
2019

Page
32 / 32